



TOP - 415/435M-120HC









108 CELL
Mono N - Type Module

415 - 435Wp
Power Output Range

Single Glass
White Backsheet

22.28%
Maximum Efficiency

KEY SALIENT FEATURES

-  Industry leading lowest thermal co-efficient of power
-  Industry leading 15 years product warranty
-  Excellent low irradiance performance
-  Excellent PID resistance
-  Positive power tolerance of 0~+3%
-  Fully automated production at all stages
-  Fully Reduced power loss by minimizing the effect of shadow shading (9 - 18 Busbar)
-  EU Brand & european after sales service



TAMESOL BUILDING A GREEN FUTURE S.L

TAMESOL is a global provider of high-efficiency PV panels with a 10GW annual production capacity and a 100% automated production line, innovating state-of-the-art products for over 15 years. Our panels have been installed in more than 50 countries, with over 20 million panels already connected to the grid.

Tel : **+34 933 801 596**
E - mail: **info@tamesol.com** Website: **www.tamesol.com**

LINEAR PERFORMANCE WARRANTY

15 year Product Warranty / 30-Year Linear Power Warranty

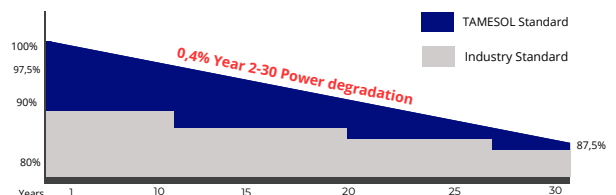

22,28%

MAX MODULE
EFFICIENCY

0 - +3%

POWER
TOLERANCE

1,0%

FIRST YEAR POWER
DEGRADATION

0,40%

YEAR 2-30
POWER DEGRADATION

N-TYPE CELL

Lower operating temperature

ELECTRICAL CHARACTERISTICS

STC: AM1.5 1.000W/m2 NOTC: AM1.5 800W/m2 20° 1 m/s Test uncertainty for Pmax 0 - +3%

Module type	TOP - 415M-108HC		TOP - 420M-108HC		TOP - 425M-108HC		TOP - 430M-108HC		TOP - 435M-108HC	
	STC	NOTC	STC	NOTC	STC	NOTC	STC	NOTC	STC	NOTC
Testing condition	STC	NOTC	STC	NOTC	STC	NOTC	STC	NOTC	STC	NOTC
Maximum Power (Pmax/w)	415	312	420	316	425	320	430	323	435	327
Open Circuit Voltage (Voc/V)	37,92	36,01	38,11	36,20	38,30	36,39	38,49	36,57	38,68	36,75
Short Circuit Current (Isc/A)	13,99	11,08	14,07	11,15	14,15	11,22	14,23	11,26	14,31	11,33
Voltage at Maximum Power (Vmp/V)	31,32	29,74	31,51	29,93	31,70	30,12	31,88	30,29	32,06	30,46
Current at maximum Power (Imp/A)	13,25	10,49	13,33	10,56	13,41	10,63	13,49	10,67	13,57	10,74
Module Efficiency (%)	21,25%		21,51%		21,76%		22,02%		22,28%	

MECHANICAL PARAMETERS

Cell Orientation single crystal N-Topcon 182x91mm (144 pieces)

Junction Box IP68, three diodes

Output Cable 300mm(+) customized

Glass 3.2mm tempered coated glass, low iron

Frame Anodized aluminum alloy frame

Weight 20,5/ 21,5/ 24 kg

Dimensión 1722/1766*1134*30mm

Packaging 31/36/37pcs*pallet /806/ 936/962pcs*40HC

PHYSICAL CHARACTERISTICS

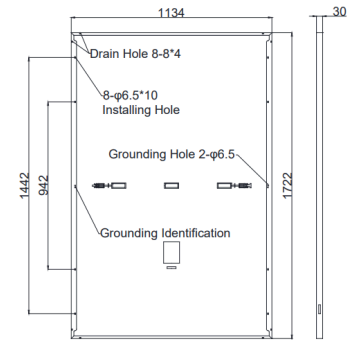
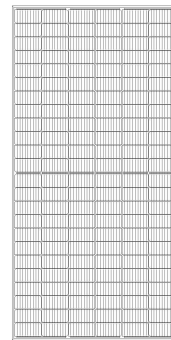

OPERATING PARAMETERS

Operational Temperature -40°C - +85°C

Power Output Tolerance (0, +3%)

Maximum System Voltage 1500V DC

Maximum Series Fuse Rating 25 A

Nominal Operating Cell Temperature 45±2°C

Protection Glass Class II

Fire Rating Class C

MECHANICAL LOADING

Front Side Maximum Static Loading 5400 PA

Rear Side Maximum Static Loading 2400 PA

TEMPERATURA RATINGS (STC)

Temperature Coefficient of Isc +0.046%/°C

Temperature Coefficient of Voc -0.25%/°C

Temperature Coefficient of Pmax -0.30%/°C

PACKING MANNER

Container 40ft(HQ)

Number of modules per container 806/936/962

Number of modules per pallet 31/36/37

Number of pallets per container 26

TAMESOL Authorized Solar Dealer

Note: The specifications are obtained under the Standard Test Conditions (STCs): 1000 W/m2 solar irradiance, 1.5 Air Mass, and cell temperature of 25°C. The NOCT is obtained under the Test Conditions: 800 W/m2, 20°C ambient temperature, 1m/s wind speed, AM 1.5 spectrum.

Please contact info@tamesol.com for technical support. The actual transactions will be subject to the contracts. This parameter is for reference only and it is not a part of the contracts. The specifications are subject to change without prior notice.